

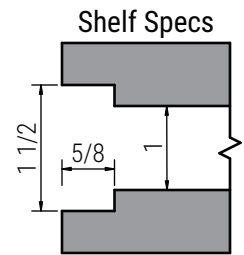

T-LOC 1510-8 Specs

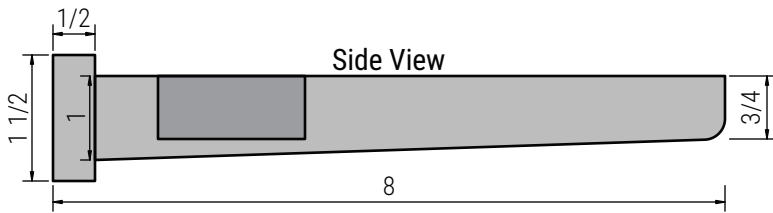
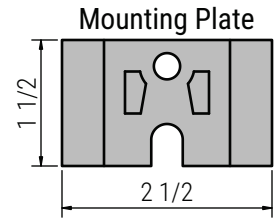
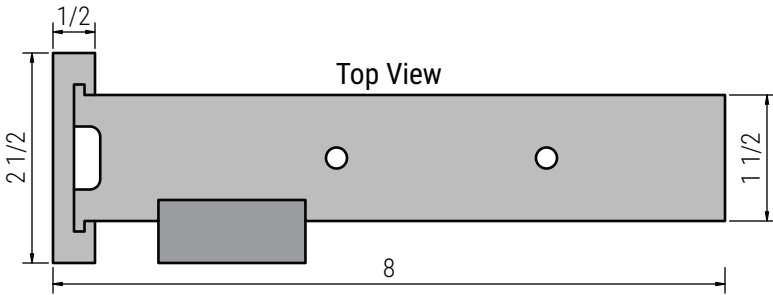
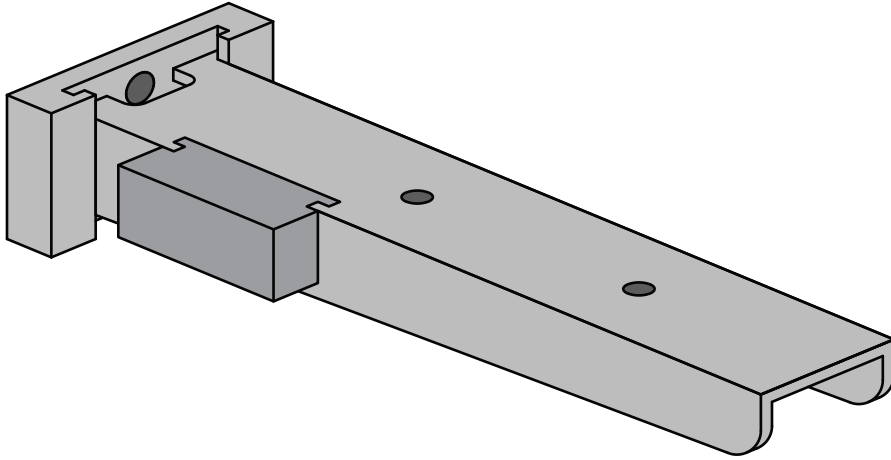

Weight Limit [per bracket]

- Wood Stud: 120 lb
- 1/2" Drywall: 40 lb
- 18ga Steel Stud: 60 lb
- Concrete: 100 lb

Deflection [wood stud application]

- 90 lb: 1/8"
- 135 lb: 1/4"
- 275 lb: 1/2"